



Description

Alloy Thermal-Link / Alloy Thermal Cutoff (ATCO) is defined as a non-resettable protective device functioning one time only. It is widely used in electrical equipment. ATCO is mainly consist of fusible alloy, flux resin, case, sealant and lead wires. Normally, fusible alloy is jointed to the two lead wires. Under abnormal conditions, when the temp. reaches to the fusing temp. of ATCO, the fusible alloy melts and quickly retracts to the two lead wire ends with the aid of the flux resin and disconnects the circuit completely.

Features

- Ceramic Case
- Flat Leads
- Non-Resettable
- High Accuracy of Functioning Temp.
- High Operating Voltage
- RoHS & REACH Compliant

Applications

- Surge Protective Devices
- Batteries
- Automobile Electronic

Customization



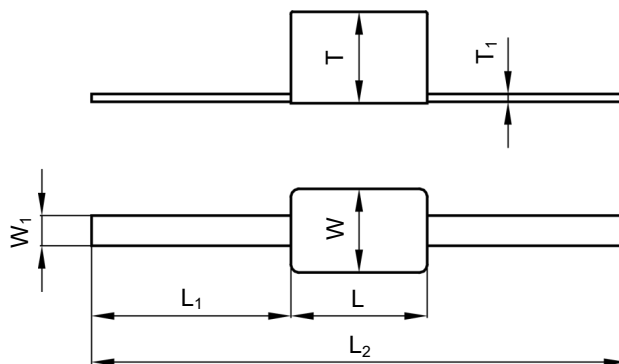

- Other Temp.
- The Length of Lead Wires

Dimensions (mm)



L	L ₁	L ₂	W	W ₁	T	T ₁
8.6 ± 1.0	30.0 ± 2.0	70.0 ± 3.0	7.6 ± 1.0	5.0 ± 1.0	6.0 ± 1.0	0.5 ± 0.1

Agency Approvals

Agency	Standards	File No.
	UL 60691	E214712
	CAN-CSA-E60691	E214712
	EN 60691	R50337988
	GB/T 9816	2016010205860216

Structure Diagrams

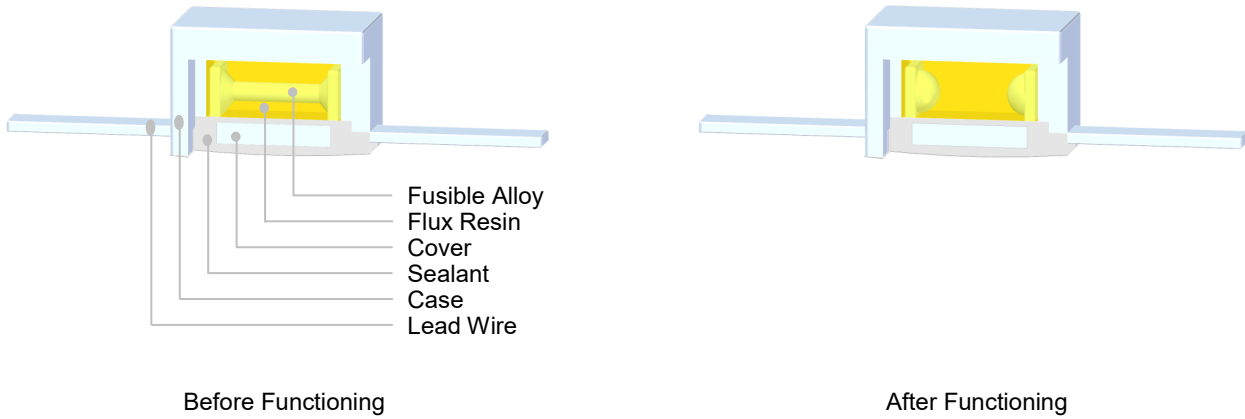

Marking

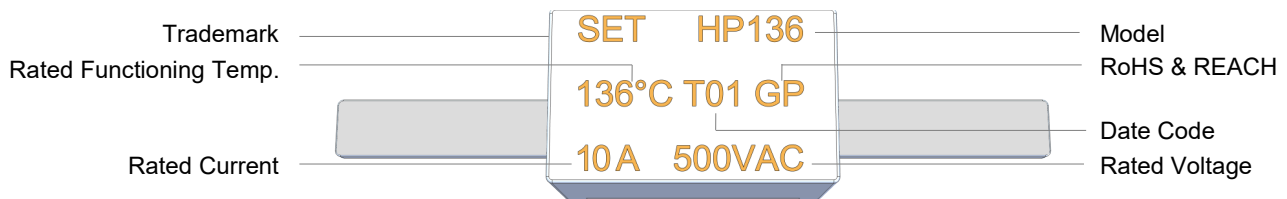

Part Numbering System

ATCO - HP 136 - E N N A B - 001

ATCO



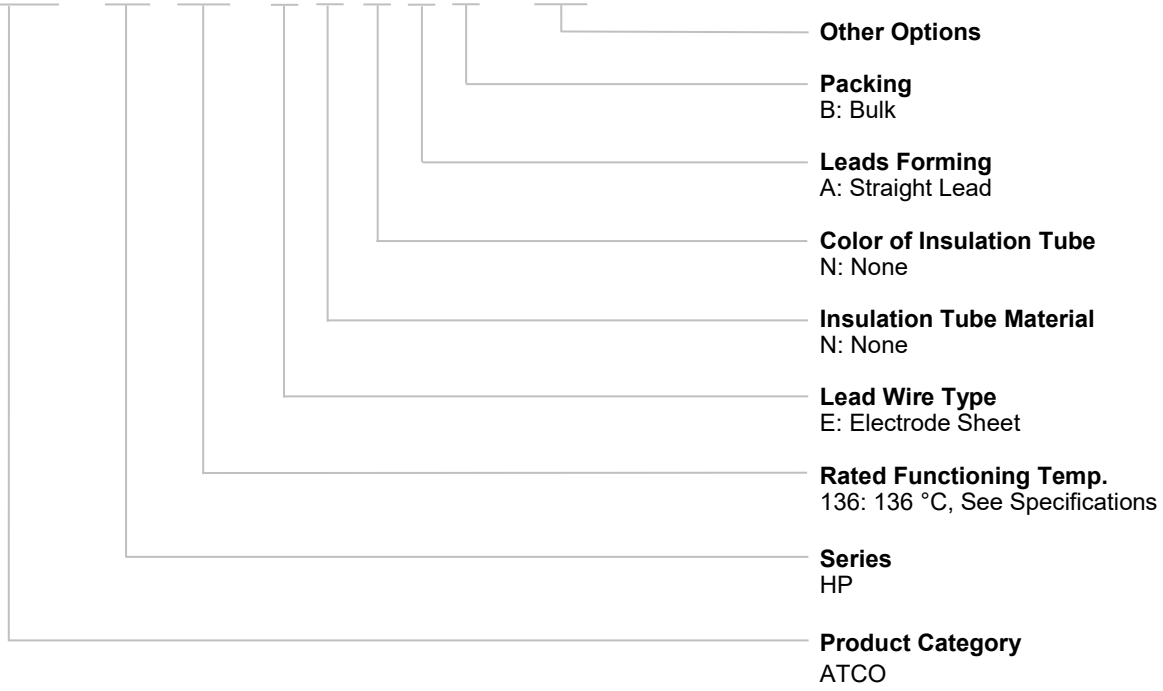

ATCO



Glossary

Item	Description
TCO	Thermal-Link A non-resettable device incorporating a THERMAL ELEMENT which will open a circuit once only when exposed for a sufficient length of time to a temperature in excess of that for which it has been designed.
ATCO	Alloy Thermal-Link Alloy Type Thermal-Link, Alloy is the thermal element.
T_f	Rated Functioning Temp. The temperature of the Alloy Thermal-Link which causes it to change the state of conductivity with a detection current up to 10 mA as the only load. Tolerance: $T_f \pm 10^\circ \text{C}$ (GB/T 9816, EN 60691, K60691). Tolerance: $T_f \pm 7^\circ \text{C}$ (J60691).
Fusing Temp.	Fusing Temp. The temperature of the Alloy Thermal-Link which causes it to change its state of conductivity is measured with silicone oil bath in which the temperature is increased at the rate of 0.5°C to 1°C / minute, with a detection current up to 10 mA as the only load.
T_h	Holding Temp. The Maximum temperature at which a Alloy Thermal-Link will not change its state of conductivity when conducting rated current for 168 hours.
T_m	Maximum Temp. Limit The temperature of the Alloy Thermal-Link stated by the manufacturer, up to which the mechanical and electrical properties of the Alloy Thermal-Link having changed its state of conductivity, will not be impaired for a given time.
I_r	Rated Current The current used to classify a Alloy Thermal-Link, which is the Maximum current that Alloy Thermal-Link allows to carry and is able to cut off the circuit safely.
U_r	Rated Voltage The voltage used to classify a Alloy Thermal-Link, which is the Maximum voltage that Alloy Thermal-Link allows to carry and is able to cut off the circuit safely.

Specifications

Model	T_f	Fusing Temp.	T_h	T_m	I_r	U_r					RoHS, REACH
	(°C)	(°C)	(°C)	(°C)	(A)	(V)	UL	cUL	TUV	CCC	
HP125	125	121 ± 2	90	250	10	AC 500	●	●	●	●	●
						DC 200					
HP136	136	131 ± 2	106	250	10	AC 500	●	●	●	●	●
						DC 200					
HP145	145	140 ± 2	112	250	10	AC 500	●	●	●	●	●
						DC 200					

Note:

"●"Means certificated.

"○"Means non-certificated.

ATCO

ATCO

Product Temp.-Time Curve (Reference)

The Temp.-Time Curve of Thermal-Link in different temp. oil bath.

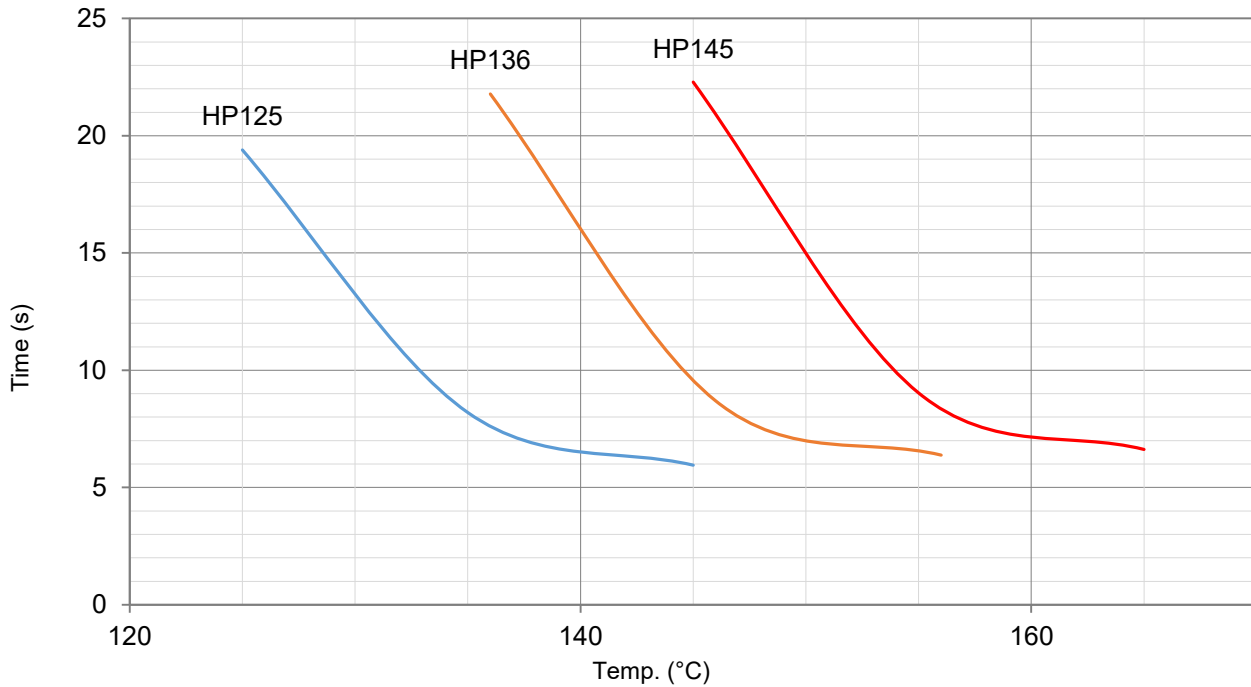

Product Current-Time Curve (Reference)

The Current-Time Curve shows functioning time at multi-times rated current at room temperature 25 ± 2 °C.

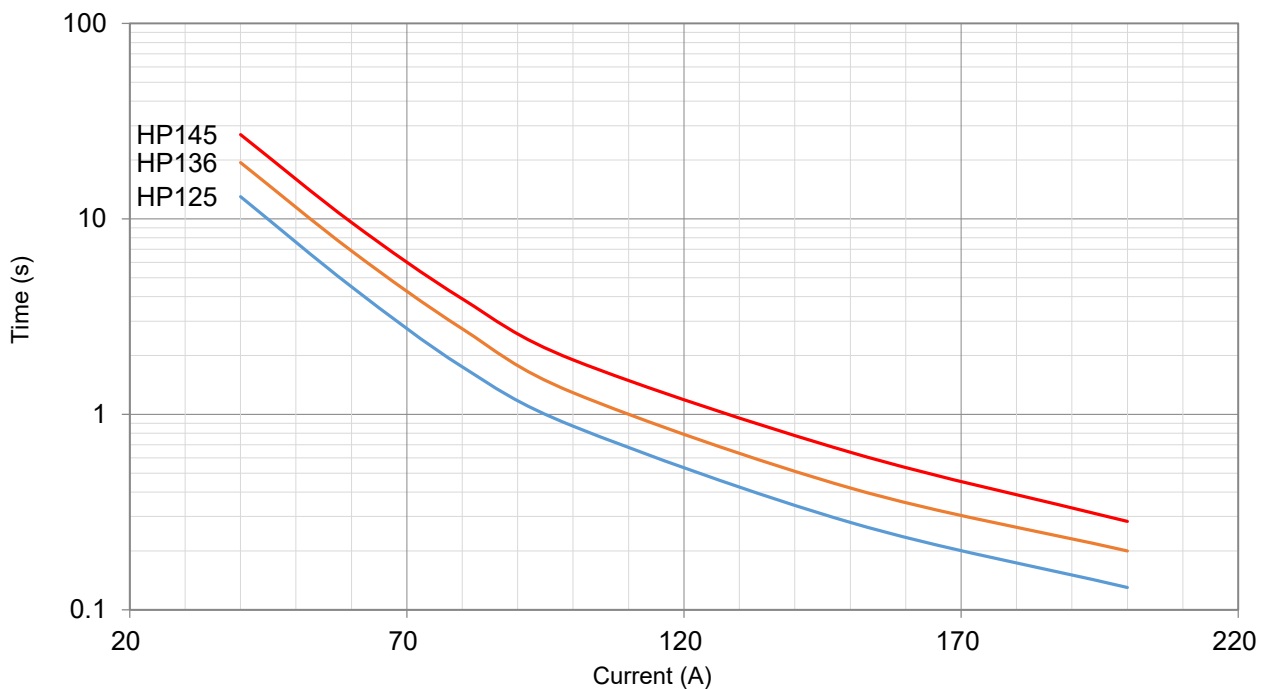

Packaging Information

Bulk

Item	PE Bag	Box	Carton
Dimensions (mm)	135 × 85	255 × 88 × 98	440 × 300 × 260
Quantity (PCS)	20	300	3000
Gross Weight (kg)			9 ± 10%

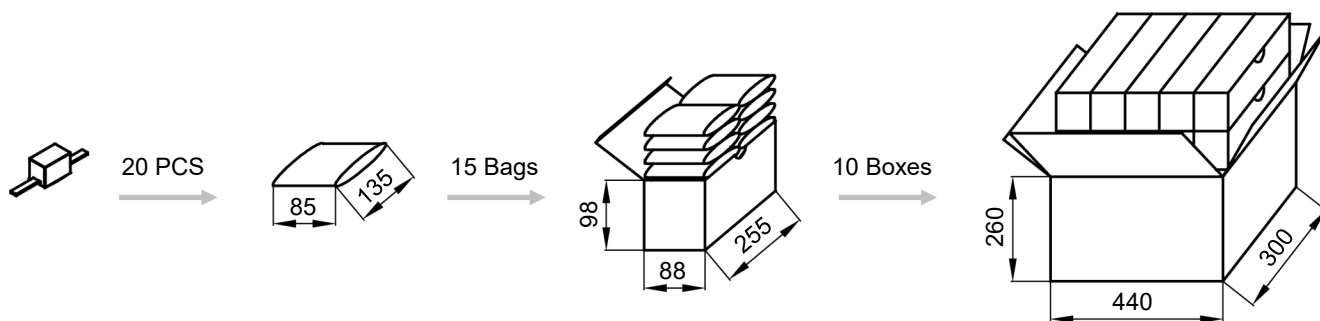



ATTENTION

Usage

1. When atmosphere pressure is from 80 kPa to 106 kPa, the related altitude shall be from 2000 meter to - 500 meter.
2. Operating voltage less than rated voltage of ATCO, operating current less than rated current of ATCO.
3. Do not touch the ATCO body or lead wires directly when power is on, to avoid burn or electric shock.

Replace

ATCO is a non-repairable product. For safety sake, it shall be replaced by an equivalent ATCO from the same manufacturer, and mounted in the same way.

Storage

Do not store the ATCO at the high temp., high humidity or corrosive gas environment, avoid influencing the solder-ability of the lead wires, the product shall be used up within 1 year after receiving the goods.

Installation

Make Sure the Temp. of Installation Position.

1. It is recommended that a dummy ATCO with inbuilt thermo-couple shall be used to determine the proper temp.
2. The terminal product should be tested to ensure that potential abnormal conditions do not cause ambient temp. to exceed the T_m of the ATCO.
3. Mount the ATCO at the location where temp. rises evenly.

Installation position of mechanical performance requirements.

1. Do not locate the ATCO in a place where severe vibration always occurs.
2. Ensure that the lead wire is long enough, and avoid actions such as press, tensile or twist.
3. The seal or body of ATCO must not be damaged, burned or over heated.

Mechanical Connection

Riveting

1. Choose small resistivity riveting material and be riveted.
2. A flexible lead or lead with low resistance should be used to rivet the ATCO.
3. Contact resistance should be minimal, Large contact resistance will lead to higher temp., ATCO Functioning in advance.

Crimping

1. Choose small resistance material to crimp.
2. Crimping process, to ensure that the lead will not be reversed, sealing resin will not be destroyed.
3. Contact resistance should be minimal, large contact resistance will cause higher temp., to make ATCO Function in advance.

Soldering

Hand-Soldering

1. Soldering should be carried out according to Table HP-1.
2. The thermal element of ATCO is fusible alloy with low melting point, which is jointed with ATCO lead wires. Improper soldering operation (too high soldering temp. , too long soldering time, too short lead wire etc.) may transfer more heat to the thermal element and ATCO may open in advance.
3. When soldering conditions are more severe than those listed in Table HP-1, a heat sink fixture should be used between soldering point and ATCO body.
4. When soldering, please do not pull / push or twist ATCO body or lead wires.
5. After soldering, let it naturally cool for longer than 20 seconds. During cooling, never move the ATCO body or lead wires.

TABLE HP-1 Hand-Soldering Time

Rated Functioning Temp. (T_i)	Max. Allowable Soldering Time for Different Lead Wire Length (Fig.HP-1)						Max. Soldering Temp.
	L_s Length	Time	L_s Length	Time	L_s Length	Time	
(°C)	(mm)	(s)	(mm)	(s)	(mm)	(s)	(°C)
76 to 101	10	1 ^a	20	2	30	3	400
102 to 115	10	1 ^a	20	2	30	3	
116 to 135	10	1 ^a	20	3	30	5	
136 to 150	10	3	20	5	30	5	
151 to 230	10	4	20	6	30	7	

Note:

a: Auxiliary Heat Sink Fixture is Required to Avoid ATCO Cutting off Unexpectedly.

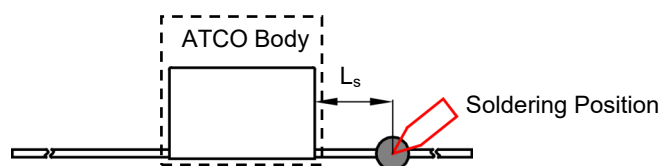
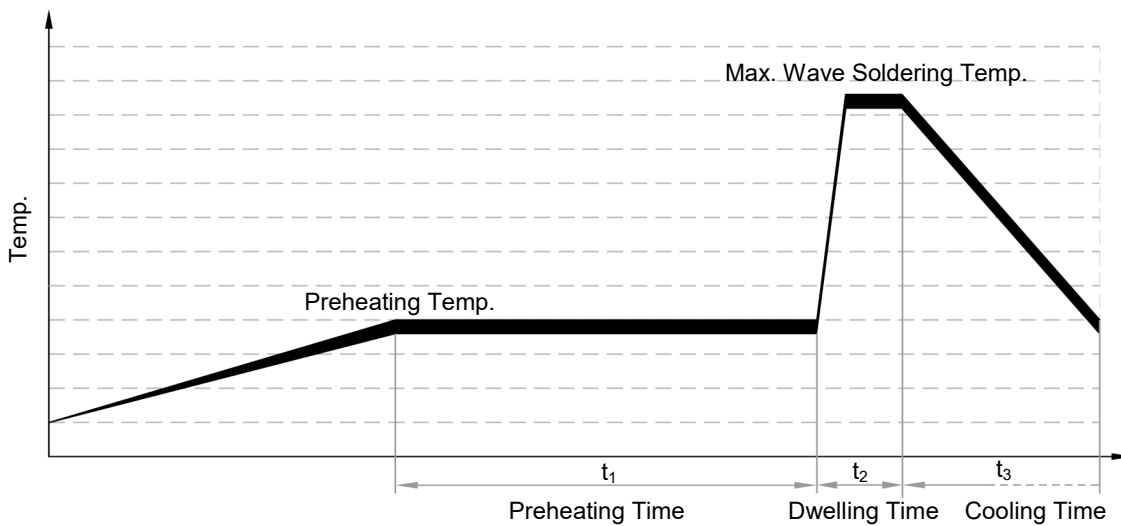

FIGURE HP-1

TABLE HP-2 Wave Soldering Parameters Setting

Rated Functioning Temp. (T_r)	Max. Allowable Preheating Temp. When the Length of Lead Wire is Different (Fig.HP-1)				Preheating Time (t_1)	Max. Wave Soldering Temp.	Dwelling Time (t_2)	Cooling Time (t_3)
	L_s Length	Preheating Temp.	L_s Length	Preheating Temp.				
(°C)	(mm)	(°C)	(mm)	(°C)	(s)	(°C)	(s)	(s)
76 to 130	Recommend Hand-Soldering							
131 to 150	20	80	30	90	< 60	≤ 260	≤ 3	≤ 10
151 to 230	20	90	30	100	< 60	≤ 260	≤ 3	≤ 10



Lead Wire Forming

1. If lead wire has to be bent, please pay attention to the distance between body and bending point. Refer to Table HP-3.
2. When bending leads, please use pincher or similar tools to fix the product as shown in Fig.HP-2, to avoid damaging the product.
3. During forming and mounting, lead wire should not be cut, nicked, bent sharply, to avoid breaking the product.
4. Tangential forces on the leads must be avoided (i.e. pushing or pulling on the leads at angle to ATCO body) as such forces may damage the seal of ATCO.

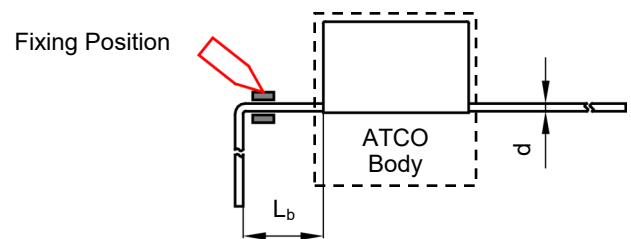

FIGURE HP-2

TABLE HP-3 Distance between Body and Bending Point

d	(mm)	≤ 1.0	1.0 to 1.2	> 1.2
L_b	(mm)	≥ 3	≥ 5	≥ 10